



# ATLAS

**DIVAN D'EXAMEN ÉLECTRIQUE**  
***ELECTRIC EXAMINATION TABLE***

Capacité / Capacity  
**385 KG**

L'assurance du confort, de la sécurité et de la dignité de vos patients  
*Comfort, safety and patient dignity ensuring efficient patient care*



## Sécurité totale – Total safety

Le divan ATLAS, avec une capacité de charge de 385 kg, permet de lever vos patients en toute sécurité, rapidement et pour longtemps (testé en statique à 2 000 kg par un organisme indépendant). Équipé de capteurs de sécurité, les mouvements du divan s'arrêtent instantanément en cas de faible pression sur la base de divan.

*The ATLAS table, with its 385kg weight capacity, enables you to safely lift your patients time and time again (tested at a static weight of 2000kg by an independent organisation). Equipped with safety sensors, table movements are immediately stopped if pressure is applied to the base cover.*



Position basse  
Low position



Position d'accueil  
Welcome position



Procline  
Reverse trendelenburg



Déclive  
Trendelenburg



capacité  
**385 kg**  
capacity



**14200-10**

## Multipositions – Multiposition

Les mouvements du dossier, d'élévation et de procline/déclive sont électriques pour faciliter votre examen.

*Electrical backrest, height, seat tilt adjustments and Trendelenburg movements ensure that your examination is more efficient.*



## Accessibilité et dignité pour vos patients Accessibility and dignity for your patients

Le divan ATLAS a une hauteur minimum d'accueil de 48 cm, indispensable pour placer vos patients sur le divan et les relever avec une assistance minimum. Une largeur d'assise de 81 cm offre à votre patient le confort qu'il est en droit d'attendre.

*The ATLAS table has a 48cm low height, ideal for patients to get onto and off the table safely and with minimal assistance. An 81cm wide seat provides the comfort and support your patient deserves.*



## Hygiène - Hygienic

L'entretien du divan ATLAS est rapide et facile; sellerie sans couture et carter ABS recouvrant. Les roulettes optionnelles facilitent le nettoyage sous la table.

*Cleaning of the ATLAS table is quick and easy due to its seamless upholstery and formed ABS base. The optional castors allow for easy cleaning under the table.*

## CARACTÉRISTIQUES STANDARD STANDARD FEATURES

Dossier réglable par vérin électrique (angle d'inclinaison de 0° à 65°)  
Electric backrest adjustment (backrest angle from 0° to 65°)

Hauteur variable électrique de 48 cm à 88 cm  
Electric height adjustment from 48cm to 88cm

Procline/Décline de -15° à +15°  
Trendelenburg/Reverse trendelenburg from -15° to +15°

Commande manuelle  
Electric handset

Support rouleau papier (largeur maxi 60 cm Ø maxi 15 cm)  
Paper roll holder (max. width 60cm max. Ø 15cm)

Structure acier avec habillage ABS gris nuage  
Steel frame with light grey ABS casing

Sellerie plate sans couture  
Seamless flat upholstery

Poids maximum du patient autorisé 385 kg (testé en dynamique à 500 kg et en statique à 2 000 kg)  
385kg patient weight capacity (tested at a dynamic weight of 500kg and a static weight of 2000kg)



Commande manuelle  
Handset



Support rouleau papier  
Paper roll holder

## ACCESSOIRES - ACCESSORIES

85114-01



Paire de barrières  
Pair of barriers

14220-01



Commande par pédale  
Pedal control

166



Paire d'étau  
Pair of clamps

2985-01

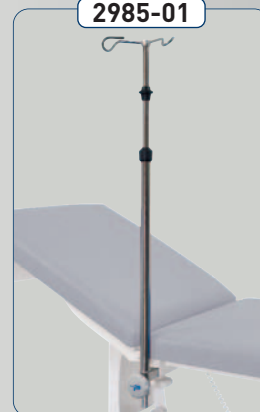

Tige porte sérum  
IV pole

MAXI  
88 cm

MINI  
48 cm

14230-01



4 roulettes ø 75 mm avec freins  
4 castors ø 75mm with brakes

## OPTION

Capacité de charge sur roulettes : 295 kg (roulettes permettant le déplacement du divan, sans patient, pour nettoyage. Hauteur variable avec roulettes : 50 à 90 cm).

*295kg weight capacity with castors (castors allow for the table to be moved, without patients, for cleaning. Height adjustment with castors from 50 to 90cm).*

## DIMENSIONS (mm)

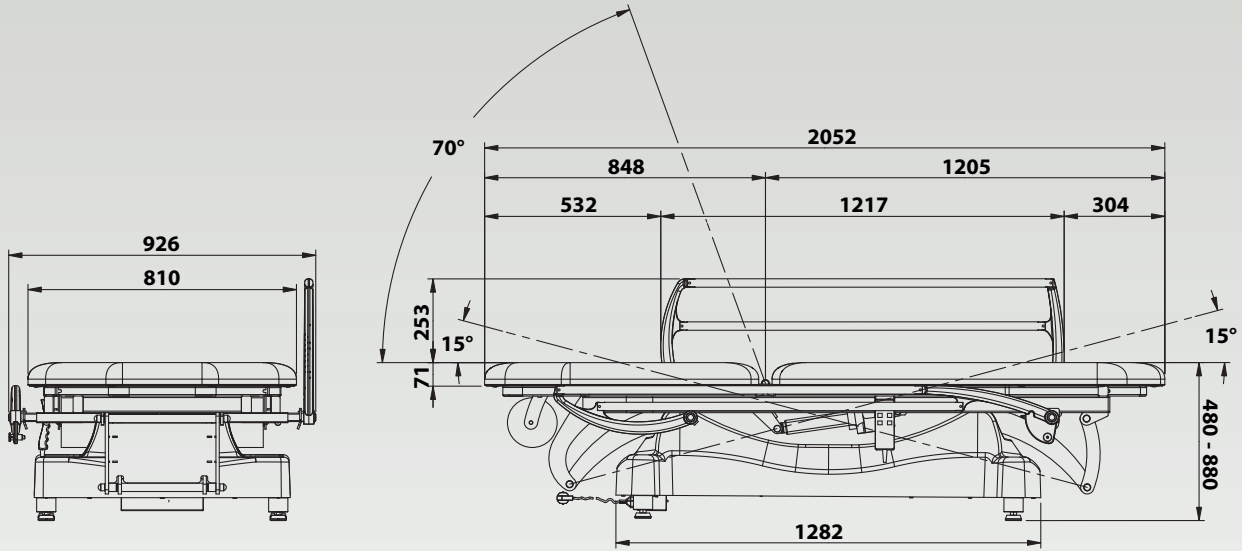

Poids net / Net weight ..... 140 kg    Poids brut / Gross weight ..... 223 kg    Volume ..... 1,22 m<sup>3</sup>

## CHOIX DES COULEURS DE SELLERIES - CHOICE OF UPHOLSTERY COLORS

### REVÊTEMENT NON-FEU M1 / M1 UPHOLSTERY

#### Basic



32 - BLEU / BLUE



33 - VERT / GREEN



34 - JAUNE / YELLOW



35 - ROUGE / RED



36 - ORANGE / ORANGE

#### Trendy



62 - AZUR / AZURE

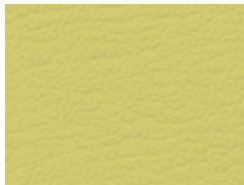

63 - CEDRAT / CEDRAT



64 - RAISIN / GRAPE

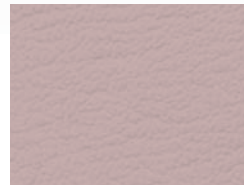

65 - LILAS / LILAC

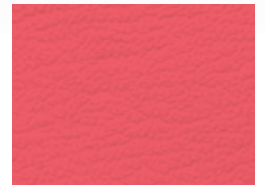

66 - BONBON / SWEET

#### Classic



92 - MARINE / MARINE



93 - COTTAGE / COTTAGE



94 - MUSCADE / NUTMEG

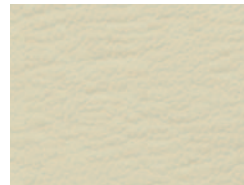

95 - NÉVÉ / FIRN

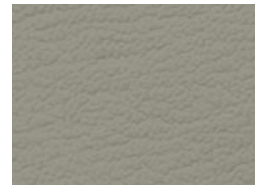

96 - ÉTAIN / TIN

#### Noirs



56 - OBSCURE / DARKNESS

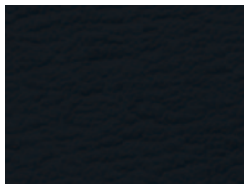

57 - ANTISTATIC\* / ANTISTATIC\*

\* Non classé M1  
Not classified M1

### REVÊTEMENT RITTER\*\* RITTER UPHOLSTERY\*\*



C1 - NAVY



C2 - DUSTY BLUE



C3 - MOSS

\*\* Uniquement pour certains produits de la gamme Promotal.  
Only for some products from Promotal range.



**PROMOTAL**

A002/FE-04/09

PROMOTAL - FRANCE | [www.promotal.com](http://www.promotal.com)

**MIDMARK**